

宁波市鄞州中晶电子技术有限公司
Ningbo Yinzhou Zhongjing Electronic Technology Co., Ltd

地址/Add : 宁波市鄞州区云龙镇南丰路四号
电话/Tel : 0574-88079460
传真/Fax : 0574-88079463
邮箱/E-mail : 13738829545@126.com
网址/Web : www.nbmcu.net

宁波市鄞州中晶电子技术有限公司
Ningbo Yinzhou Zhongjing Electronic Technology Co., Ltd



宁波市鄞州中晶电子技术有限公司



公司简介 <<<

宁波市鄞州中晶电子技术有限公司是一家全球化的电子产品研发和生产企业，主要产品包括自动门电子配件、门禁门控产品以及自动感应卫浴产品。“中晶”（ZHONGJING）系列产品广泛应用于自动感应门控制系统、楼宇门禁考勤系统、银行管理系统以及公共自动卫浴系统。

中晶产品主要是配套自动感应门以及卫浴的生产商和安装工程商以及贸易商。在过硬的技术基础上给客户更具性价比的产品。领先的技术奠定产品的稳定根基，精美的外观迎合市场的需求，优质的服务让售后无忧。中晶，改变你的生活。

中晶产品包括：微波感应器、红外感应器、门禁刷卡器、感应门功能开关、红外防撞感应器、非触摸开关、有线手压开关、无线手压开关、单光束安全光线、双光束安全光线、三光束安全光线、自动门后备电源、门禁专用电源、出门按钮开关、电插锁、电磁锁、指纹机等配件。

Company Introduction

Ningbo Yinzhou Zhongjing Electronic Technology Co., Ltd is a professional manufacturer of electronics for automatic door & gate. Our main products are microwave sensor, infrared sensor, safety sensor, access system, auto door function selector, wired and wireless button, electric lock, photocell and alarm lamp, etc. Under rich experienced R&D background on electronics, our products' stability, durability and reliability are well achieved. All of our products are with CE approval, getting more and more popular all over the world, based on fashion design, high quality, good service.

Zhongjing has a strict production management system and quality control system, to give always high quality products.

Zhongjing, your solution.

Automatic door accessories.....	5-29
Microwave sensor.....	5-7
Infrared sensor.....	7-15
Function selector.....	15-20
Electric lock.....	20
Push button.....	21-25
Access keypad.....	26-27
Finger print.....	28
Power for access.....	28
UPS.....	29

Automatic gate accessories.....	31-41
Photocell.....	31-34
Alarm lamp.....	34-37
Vehicle loop detector.....	37-39
Key switch.....	40
Waterproof finger printer.....	41

Access system.....	43-48
Card reader.....	43
Electric bolt lock.....	43-44
Electric magnetic lock.....	44-48

自动感应门配件.....	5-29
微波感应器.....	5-7
红外感应器.....	7-15
功能选择器.....	15-20
电子锁.....	20
按钮开关.....	21-25
刷卡器.....	26-27
指纹机.....	28
门禁电源.....	28
后备电源.....	29

自动门机配件.....	31-41
安全对射.....	31-34
警灯.....	34-37
地感.....	37-39
钥匙开关.....	40
防水门禁.....	41

门禁系统.....	43-48
读头.....	43
电插锁.....	43-44
电磁锁.....	44-48

微波感应器



红外感应器



功能选择器



按钮开关



刷卡器



指纹机



YS505

门禁电源/后备电源



YS316



YS317

红外对射



YS119



YS120



YS120-L



YS121



YS121-L



YS122



YS123

警灯



YS415



YS419



YS420



YS421



YS422



YS319

地感



YS124



YS125



YS126



YS127



YS128

钥匙开关



YS416



YS417



YS418

读卡头



YS522



YS523



YS524



YS526

电子锁

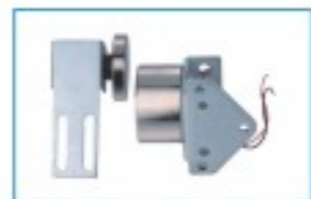

YS210



YS202-2



YS205-1



YS660



YS6-180



YS6-280



YS6-500



YS6-180M



YS6-280M



YS6-180A



YS6-280A



YS6-350A

YS101

Microwave sensor
微波感应器



Product features:

1. Detecting range is large enough, and can be adjusted easily.
2. Electric filter provide a good capacity of resisting disturbance from raining, wind, lighting and so on.

产品特点:

1. 感应可调节范围广, 有利于各个场所的应用。
2. 具有电子滤波功能, 使得抗干扰能力强, 有效适应下雨、刮风、日光灯等特殊情况。

Size 尺寸:

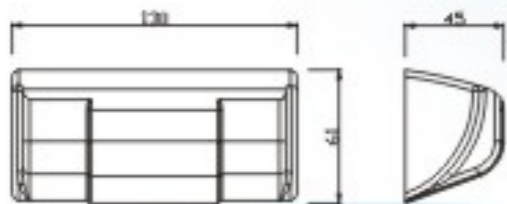

Technical data 技术参数:

Power supply	AC 12-24V +/-10%; DC 12-30V
电源输入	AC 12-24V +/-10%; DC 12-30V
Mounting height	Max 3.5m
最大安装高度	3.5m
Relay output	NO
继电器输出	常开输出
Wave form	24.125GHZ
电波形式	24.125GHZ

YS103

Microwave sensor
微波感应器



Product features:

1. Detecting range is large enough, and can be adjusted easily.
2. Electric filter provide a good capacity of resisting disturbance from raining, wind, lighting and so on.

产品特点:

1. 感应可调节范围广, 有利于各个场所的应用。
2. 具有电子滤波功能, 使得抗干扰能力强, 有效适应下雨、刮风、日光灯等特殊情况。

Size 尺寸:

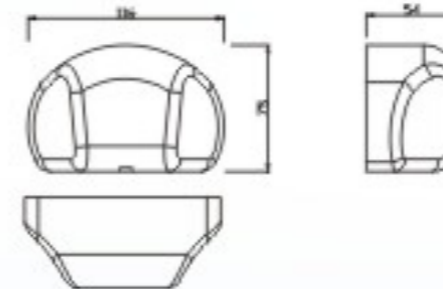

Technical data 技术参数:

Power supply	AC/DC 12-36V
电源输入	AC/DC 12-36V
Mounting height	Max 3m
最大安装高度	3m
Relay output	NO
继电器输出	常开输出
Wave form	X-Band 10.525GHZ
电波形式	X-Band 10.525GHZ

YS102

Microwave sensor
微波感应器



Product features:

1. Germany Innosent detecting chip, 24.125GHZ.
2. Electric filter provide a good capacity of resisting disturbance from raining, wind, lighting and so on.

产品特点:

1. 采用德国进口 24.125GHZ 感应模块, 给产品的稳定性提供了有效的保证。
2. 具有电子滤波功能, 使得抗干扰能力强, 有效适应下雨、刮风、日光灯等特殊情况。

Size 尺寸:



Technical data 技术参数:

Power supply	AC/DC 12-36V
电源输入	AC/DC 12-36V
Mounting height	Max 3.5m
最大安装高度	3.5m
Relay output	NO
继电器输出	常开输出
Wave form	24.125GHZ
电波形式	24.125GHZ

YS104

Microwave sensor
微波感应器



Product features:

1. Germany Innosent detecting chip, 24.125GHZ.
2. The detecting chip can be adjusted easily by special part.
3. Electric filter provide a good capacity of resisting disturbance from raining, wind, lighting and so on.

产品特点:

1. 采用德国进口 24.125GHZ 感应模块, 给产品的稳定性提供了有效的保证。
2. 特殊的天线调节装置可确保感应区域的精准性。
3. 具有电子滤波功能, 使得抗干扰能力强, 有效适应下雨、刮风、日光灯等特殊情况。

Size 尺寸:



Technical data 技术参数:

Power supply	AC 12-24V +/-10%; DC 12-36V
电源输入	AC 12-24V +/-10%; DC 12-36V
Mounting height	Max 3.5m
最大安装高度	3.5m
Relay output	NO
继电器输出	常开输出
Wave form	24.125GHZ
电波形式	24.125GHZ

YS105

Microwave sensor
微波感应器



Product features:

1. Germany InnoSent detecting chip, 24.125GHZ.
2. Electric filter provide a good capacity of resisting disturbance from raining, wind, lighting and so on.

产品特点:

1. 采用德国进口 24.125GHZ 感应模块, 给产品的稳定性提供了有效的保证。
2. 具有电子滤波功能, 使得抗干扰能力强, 有效适应下雨、刮风、日光灯等特殊情况。

Size 尺寸:



Technical data 技术参数:

Power supply	AC 12-24V +/-10%; DC 12-30V
电源输入	AC 12-24V +/-10%; DC 12-30V
Mounting height	Max 3.5m
最大安装高度	3.5m
Relay output	NO
继电器输出	常开输出
Wave form	24.125GHZ
电波形式	24.125GHZ

YS106

Infrared sensor
红外感应器



Product features:

Infrared sensor's detecting range can be controlled easily. So this type sensor is well used for narrow place.

产品特点:

红外感应器的特点是感应光束容易控制, 从而可以调节出比较精准的感应区域, 从而更有效的用于如沿街店铺, 这类容易产生误感应的地方。

Size 尺寸:



Technical data 技术参数:

Power supply	AC/DC 12-36V
电源输入	AC/DC 12-36V
Mounting height	Max 3m
最大安装高度	3m
Quantity of rays	8 pairs rays
光束数量	8 对
Relay output	NO
继电器输出	常开输出

YS107

Active infrared sensor(with presence function)
启动红外防夹感应器(双光束)



Product features:

It has 2 rows of detection sensor. One is for motion detection, another is for presence detection.

When you use this type sensor, you don't need install photocell.

产品特点:

该款产品带有两排探测光束, 一排是启动感应, 另外一排是防夹感应, 避免了安装安全光线的麻烦。

Size 尺寸:

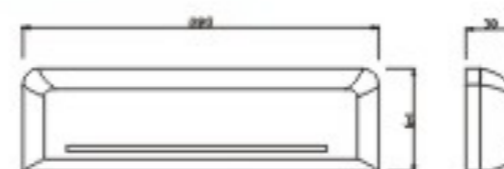

Technical data 技术参数:

Power supply	AC/DC 12-30V
电源输入	AC/DC 12-30V
Mounting height	Max 3m
最大安装高度	3m
Relay hold time	0.5 sec.
继电器保持时间	0.5 秒
Relay output	NO, NC
继电器输出	常开, 常闭

YS108

Active infrared sensor(with presence function)
启动红外防夹感应器(四光束)

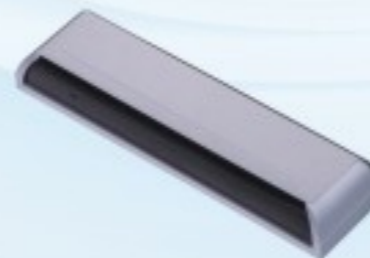

Product features:

It has 4 rows of detection sensor. One type is for motion detection, another type is for presence detection.

When you use this type sensor, you don't need install photocell.

产品特点:

该款产品带有四排探测光束, 一种是启动感应, 另外一种防夹感应, 避免了安装安全光线的麻烦。

Size 尺寸:



Technical data 技术参数:

Power supply	AC/DC 12-30V
电源输入	AC/DC 12-30V
Mounting height	Max 3m
最大安装高度	3m
Relay hold time	0.5 sec.
继电器保持时间	0.5 秒
Relay output	NO, NC
继电器输出	常开, 常闭

YS109

Motion&Presence sensor
启动防夹感应器



Product features:

Motion sensor is microwave type. It's good for large place. Presence sensor is infrared type. It's good for installation.

产品特点:

该款感应器启动部分是微波感应器,有利于用在检测区域大的场所。而且采用红外防夹功能,更有利于安装的便利。

Size 尺寸:

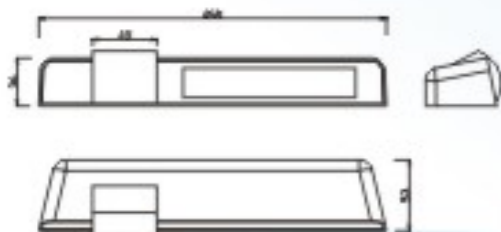

Technical data 技术参数:

Power supply	AC/DC 12-30V +/-10%
电源输入	AC/DC 12-30V +/-10%
Mounting height	Max 2.5m
最大安装高度	2.5m
Motion type	Microwave sensor
启动类型	微波感应
Presence type	Infrared sensor
防夹类型	红外感应

YS111

Active infrared sensor
移动安全光幕



Product features:

1. It can detect the moving person or objects.
2. The quantity of detecting parts can be selected to suit different width of door wings.

产品特点:

1. 可准确探测到正在移动的人体或者物体。
2. 根据不同的门扇宽度,可以选择单组或者多组感应模块,从而可以避免盲点的出现。

Size 尺寸:



Technical data 技术参数:

Power supply	AC/DC 12-36V
电源输入	AC/DC 12-36V
Detecting range	1.5-2.5m
测试范围	1.5-2.5m
Detecting parts	1 piece or 2 pieces
测试模块	1组或者2组

YS110

Presence sensor
防夹感应器



Product features:

1. Self-learning function make the installation more easier.
2. Self-recovery function can reduce the mis-detecting from sunshine, lighting, shaking.

产品特点:

1. 采用背景自学习功能,开机自动学习背景状态,自动适应各种环境。
2. 自动实时对背景作时间漂移的准确补偿。

Size 尺寸:



Technical data 技术参数:

Power supply	AC/DC 12-30V
电源输入	AC/DC 12-30V
Mounting height	Max 2.5m
最大安装高度	2.5m
Quantity of rays	8 pairs
光束数量	8对发射和接收

YS112

Ceiling presence sensor
吸顶探头



Product features:

Special design for the ceiling installation is good for ATM or the place where not easy for normal type sensor.

产品特点:

独特的外形设计,是为有特殊安装要求的场所选用的。

Size 尺寸:



Technical data 技术参数:

Power supply	AC/DC 12-30V
电源输入	AC/DC 12-30V
Mounting height	Max 2.8m
最大安装高度	2.8m
Detecting range	diameter 0.8-1.6m
探测范围	半径 0.8-1.6m

YS113

Pet presence sensor
宠物防夹



Product features:

This design is for beside installation to protect pet or children.

产品特点:

该产品是为了防止门体夹伤宠物或者孩童设计的。

Size 尺寸:

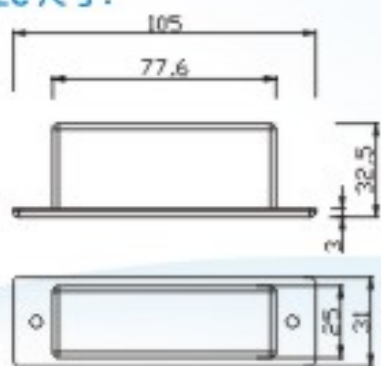

Technical data 技术参数:

Power supply	AC/DC 12-36V
电源输入	AC/DC 12-36V
Detecting range	1-80cm(adjustable)
检测范围	1-80cm 可调

YS114

Passive infrared sensor
被动红外感应器



Product features:

Small size design is good for installation. And infrared sensor is suitable for revolving or swing door's active sensor.

产品特点:

精巧的设计比较适合作为旋转门或者平开门的启动感应器。既可以适用于内藏式安装，也可以适用于明装。

Size 尺寸:

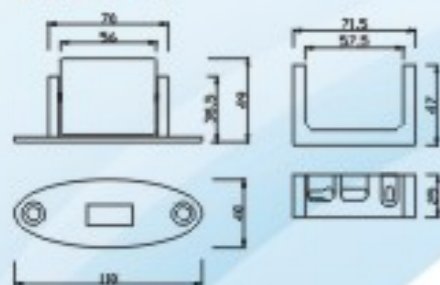

Technical data 技术参数:

Power supply	AC/DC 12-30V
电源输入	AC/DC 12-30V
Mounting height	Max 3.5m
最大安装高度	3.5 米

YS115

Photocell (single type)
安全光线 (单光束)



Product features:

1. It has N.C. and N.O. relay output, and can work with different type automatic controller.
2. The photocell's eye is made by special material to avoid the sunshine's affect.
3. The controller will alarm if the eyes having problem.

产品特点:

1. 安全光线信号输出可选择常闭和常开，适应不同自动门控制器。
2. 光电眼有阳光过滤因子，使安全光线的抗干扰性能大大提高。
3. 设有接收头短路故障报警功能。

Size 尺寸:

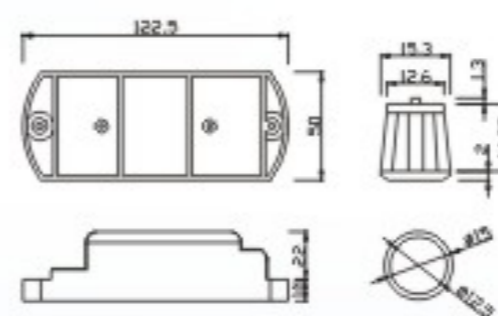

Technical data 技术参数:

Power supply	AC/DC 12-36V
电源输入	AC/DC 12-36V
Mounting distance	Max 10m
最大感应距离	10m
Relay output	NO, NC
继电器输出	常闭，或者常开

YS116

Photocell(double type)
安全光线 (双光束)



Product features:

1. It has N.C. and N.O. relay output, and can work with different type automatic controller.
2. The photocell's eye is made by special material to avoid the sunshine's affect.
3. The controller will alarm if the eyes having problem.
4. It can work with two pairs photocell's eyes.

产品特点:

1. 安全光线信号输出可选择常闭和常开，适应不同自动门控制器。
2. 光电眼有阳光过滤因子，使安全光线的抗干扰性能大大提高。
3. 设有接收头短路故障报警功能。
4. 可接双光束。

Size 尺寸:

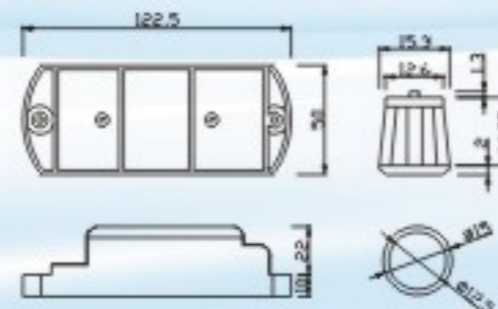

Technical data 技术参数:

Power supply	AC/DC 12-36V
电源输入	AC/DC 12-36V
Mounting distance	Max 10m
最大感应距离	10m
Relay output	NO, NC
继电器输出	常闭，或者常开

YS117

Photocell(triple type)
安全光线 (三光束)



Product features:

1. It has N.C. and N.O. relay output, and can work with different type automatic controller.
2. The photocell's eye is made by special material to avoid the sunshine's affect.
3. The controller will alarm if the eyes having problem.
4. It can work with three pairs photocell's eyes.

产品特点:

1. 安全光线信号输出可选择常闭和常开, 适应不同自动门控制器。
2. 光电眼有阳光过滤因子, 使安全光线的抗干扰性能大大提高。
3. 设有接收头短路故障报警功能。
4. 可接三光束。

Technical data 技术参数:

Power supply	AC/DC 12-30V
电源输入	AC/DC 12-30V
Mounting distance	Max 10m
最大感应距离	10m
Relay output	NO, NC
继电器输出	常闭, 或者常开

YS129

Photocell (single type)
安全光线 (单光束)



Product features:

1. It has N.C. and N.O. relay output, and can work with different type automatic controller.
2. The photocell's eye is made by special material to avoid the sunshine's affect.
3. The controller will alarm if the eyes having problem.

产品特点:

1. 安全光线信号输出可选择常闭和常开, 适应不同自动门控制器。
2. 光电眼有阳光过滤因子, 使安全光线的抗干扰性能大大提高。
3. 设有接收头短路故障报警功能。

Technical data 技术参数:

Power supply	AC/DC 12-30V
电源输入	AC/DC 12-30V
Mounting distance	Max 10m
最大感应距离	10m
Relay output	NO, NC
继电器输出	常闭, 或者常开

YS130

Photocell(double type)
安全光线 (双光束)



Product features:

1. It has N.C. and N.O. relay output, and can work with different type automatic controller.
2. The photocell's eye is made by special material to avoid the sunshine's affect.
3. The controller will alarm if the eyes having problem.

产品特点:

1. 安全光线信号输出可选择常闭和常开, 适应不同自动门控制器。
2. 光电眼有阳光过滤因子, 使安全光线的抗干扰性能大大提高。
3. 设有接收头短路故障报警功能。

Technical data 技术参数:

Power supply	AC/DC 12-30V
电源输入	AC/DC 12-30V
Mounting distance	Max 10m
最大感应距离	10m
Relay output	NO, NC
继电器输出	常闭, 或者常开

YS131

Photocell(triple type)
安全光线 (三光束)



Product features:

1. It has N.C. and N.O. relay output, and can work with different type automatic controller.
2. The photocell's eye is made by special material to avoid the sunshine's affect.
3. The controller will alarm if the eyes having problem.
4. It can work with three pairs photocell's eyes.

产品特点:

1. 安全光线信号输出可选择常闭和常开, 适应不同自动门控制器。
2. 光电眼有阳光过滤因子, 使安全光线的抗干扰性能大大提高。
3. 设有接收头短路故障报警功能。
4. 可接三光束

Technical data 技术参数:

Power supply	AC/DC 12-30V
电源输入	AC/DC 12-30V
Mounting distance	Max 10m
最大感应距离	10m
Relay output	NO, NC
继电器输出	常闭, 或者常开

YS118

Foot sensor
脚感应开关



Product features:

1. It has N.C. and N.O. relay output, and can work with different type automatic controller.
2. The photocell's eye is made by special material to avoid the sunshine's affect.
3. The controller will alarm if the eyes having problem.
4. It can work with two pairs photocell's eyes.

产品特点:

1. 安全光线信号输出可选择常闭和常开, 适应不同自动门控制器。
2. 光电眼有阳光过滤因子, 使安全光线的抗干扰性能大大提高。
3. 设有接收头短路故障报警功能。
4. 可接双光束。

Size 尺寸:

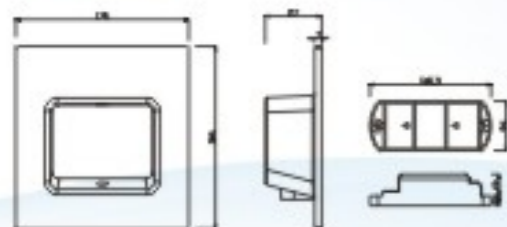

Technical data 技术参数:

Power supply	AC/DC 12-36V
电源输入	AC/DC 12-36V
Sensor type	From foot, no touch
信号来源	光束被截
Relay output	NO, NC
继电器输出	常闭, 或者常开

YS302

Automatic door function remote
自动门四键功能遥控器



Product features:

1. Learning code function, easy to add or delete remotes.
2. One receiver can match fifteen remotes, and one remote also can work with fifteen receivers.

产品特点:

1. 采用学习码功能, 方便用户增加或者删除遥控器。
2. 一个接收器可以匹配十五个遥控器, 同时一个遥控器也可以匹配十五个接收器。

Size 尺寸:

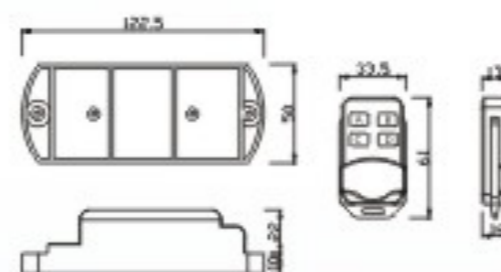

Technical data 技术参数:

Power supply	AC/DC 12-36V
电源输入	AC/DC 12-36V
Frequency	433MHz
工作频率	433MHz
Working model	Learning code
工作类型	学习码

YS301

Automatic door function remote
自动门四键功能遥控器



Product features:

1. Learning code function, easy to add or delete remotes.
2. One receiver can match fifteen remotes, and one remote also can work with fifteen receivers.

产品特点:

1. 采用学习码功能, 方便用户增加或者删除遥控器。
2. 一个接收器可以匹配十五个遥控器, 同时一个遥控器也可以匹配十五个接收器。

Size 尺寸:

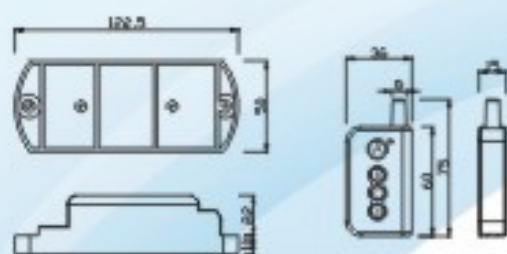

Technical data 技术参数:

Power supply	AC/DC 12-36V
电源输入	AC/DC 12-36V
Frequency	433MHz
工作频率	433MHz
Working model	Learning code
工作类型	学习码

YS303

Automatic door function remote
自动门六键功能遥控器



Product features:

1. Learning code function, easy to add or delete remotes.
2. One receiver can match fifteen remotes, and one remote also can work with fifteen receivers.

产品特点:

1. 采用学习码功能, 方便用户增加或者删除遥控器。
2. 一个接收器可以匹配十五个遥控器, 同时一个遥控器也可以匹配十五个接收器。

Size 尺寸:

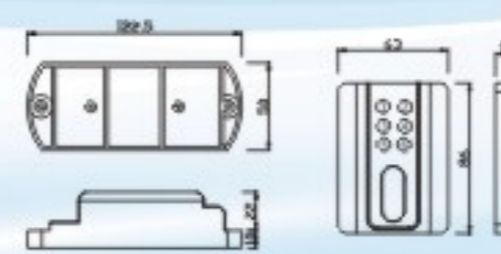

Technical data 技术参数:

Power supply	DC 24V
电源输入	DC 24V
Frequency	433MHz
工作频率	433MHz
Working model	Learning code
工作类型	学习码

YS304

Automatic door function keypad 自动门五键功能开关



Product features:

Full open, partial open, automatic, lock, one way.

产品特点:

全开、半开、自动、上锁、单向，共五项功能。

Size 尺寸:

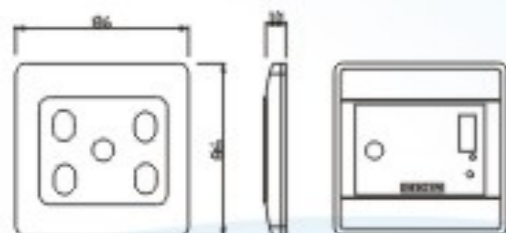

Technical data 技术参数:

Power supply	DC 12-28V
电源输入	DC 12-28V
Function switch	Five button
功能切换	五键

YS306

Automatic door function keypad 自动门五键功能触摸开关



Product features:

Full open, partial open, automatic, lock, one way.

产品特点:

全开、半开、自动、上锁、单向，共五项功能。

Size 尺寸:

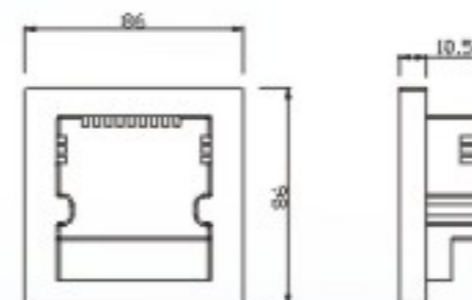

Technical data 技术参数:

Power supply	DC 12-28V
电源输入	DC 12-28V
Function switch	Five button
功能切换	五键

YS305

Automatic door function keypad 自动门五键功能开关



Product features:

Full open, partial open, automatic, lock, one way.

产品特点:

全开、半开、自动、上锁、单向，共五项功能。

Size 尺寸:

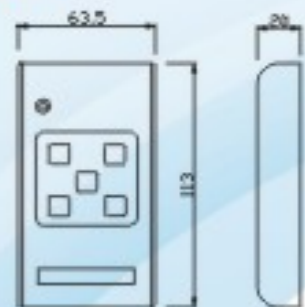

Technical data 技术参数:

Power supply	DC 12-28V
电源输入	DC 12-28V
password setting	Default password 12345
切换密码	五键 初始密码 12345

YS307

Automatic door function switch 自动门五键功能钥匙开关

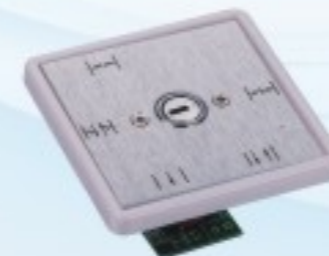

Product features:

Full open, partial open, automatic, lock, one way.

产品特点:

全开、半开、自动、上锁、单向，共五项功能。

Size 尺寸:



Technical data 技术参数:

Function switch	Five mode
功能切换	五档

YS308

Automatic door function switch
自动门五键功能旋钮开关



Product features:

Full open, partial open, automatic, lock, one way.

产品特点:

全开、半开、自动、上锁、单向，共五项功能。

Size 尺寸:



Technical data 技术参数:

Function switch	Five mode
功能切换	五档

YS310

Automatic door function switch
自动门五键功能钥匙开关



Product features:

Full open, partial open, automatic, lock, one way.

产品特点:

全开、半开、自动、上锁、单向，共五项功能。

Size 尺寸:

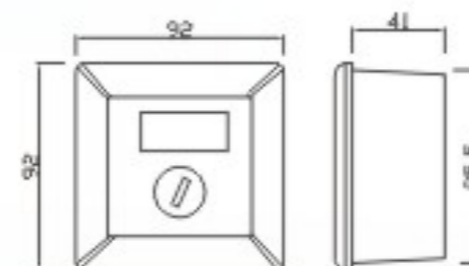

Technical data 技术参数:

Power supply	DC 12-28V
电源输入	DC 12-28V
Function switch	Five mode
功能切换	五档

YS309

Automatic door function switch
自动门五键功能钥匙开关



Product features:

Full open, partial open, automatic, lock, one way.

产品特点:

全开、半开、自动、上锁、单向，共五项功能。

Size 尺寸:

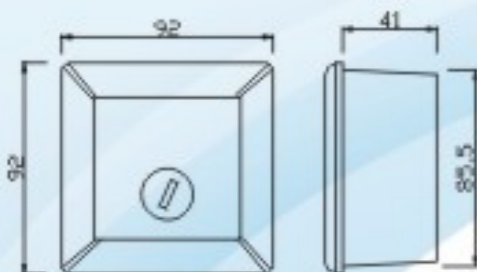

Technical data 技术参数:

Function switch	Five mode
功能切换	五档

YS210

Electric magnetic lock
自动门磁力锁



Product features:

The size of lock is small, so it's suit to most of automatic doors.

产品特点:

小巧的设计，安装方便，可以和各种款型的电敏感应器。

Size 尺寸:

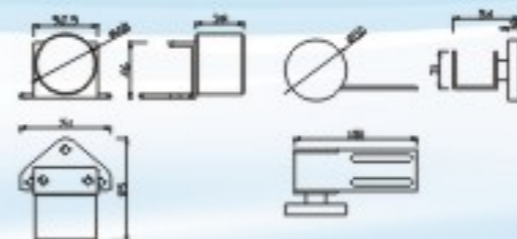

Technical data 技术参数:

Power supply	DC12V
电源输入	DC12V
Open force	60KG
拉力	60KG

YS401

Plastic push button
塑脂出门开关



Product features:

1. High temperature resistant plastic material.
2. Apply to all kinds of electronic Access control.

产品特点:

1. 耐高温混合树脂材料。
2. 按钮适用于所有电子门禁系统安装。

Technical data 技术参数:

Output connection	NO/NC connection
接点输出	NO/NC 接点

Size 尺寸:

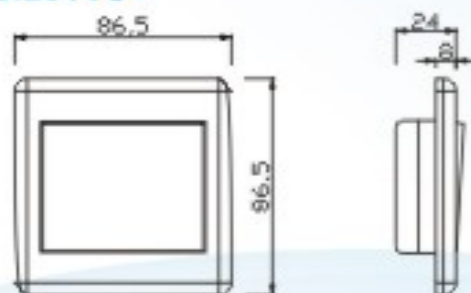

YS402

Stainless steel push button
不锈钢金属出门开关



Product features:

1. Stainless steel surface.
2. Apply to all kinds of electronic Access control.

产品特点:

1. 不锈钢面板拉丝处理。
2. 按钮适用于所有电子门禁系统安装。

Technical data 技术参数:

Output connection	NO/NC connection
接点输出	NO/NC 接点
Max current	36 V DC/3A
最大电流	36VDC / 3A

Size 尺寸:

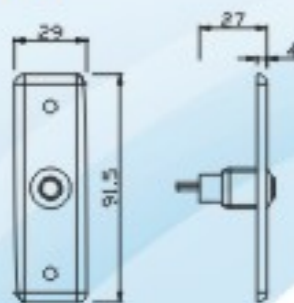

YS403

Stainless steel push button
不锈钢金属出门开关



Product features:

1. With Led display, stainless steel surface.
2. Apply to all kinds of electronic Access control.

产品特点:

1. 带LED灯显示, 不锈钢面板拉丝处理。
2. 按钮适用于所有电子门禁系统安装。

Technical data 技术参数:

Output connection	NO/NC connection
接点输出	NO/NC 接点
Max current	36 V DC/3A
最大电流	36VDC / 3A

Size 尺寸:

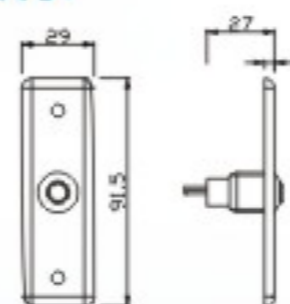

YS404

Stainless steel push button
不锈钢出门开关



Product features:

1. Stainless steel surface.
2. Apply to all kinds of electronic Access control.

产品特点:

1. 不锈钢面板拉丝处理。
2. 按钮适用于所有电子门禁系统安装。

Technical data 技术参数:

Output connection	NO/NC connection
接点输出	NO/NC 接点
Max current	36 V DC/3A
最大电流	36VDC / 3A

Size 尺寸:

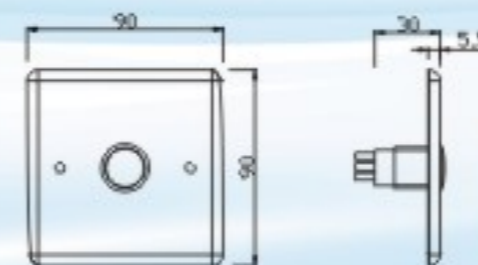

YS405

Stainless steel push button
不锈钢出门开关



Product features:

1. With Led display, stainless steel surface.
2. Apply to all kinds of electronic Access control.

产品特点:

1. 带LED灯显示, 不锈钢面板拉丝处理。
2. 按钮适用于所有电子门禁系统安装。

Size 尺寸:

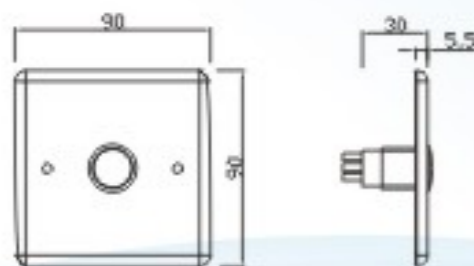

Technical data 技术参数:

Output connection 接点输出	NO/NC connection NO/NC 接点
Max current 最大电流	36 V DC/3A 36VDC / 3A

YS407

Wireless push button
无线手押开关



Product features:

1. Wireless push button, slim type can be installed for all type frame.
2. Learning code type, one receiver can match 15 pieces remotes.

产品特点:

1. 轻触按钮设计, 内置全进口防潮防尘轻触按钮。
2. 产品为自学习码, 内置拨码开关, 可错开编码使用, 防止相邻两台设备相干扰。
3. 收发拨码核对, 用户使用简洁方便。

Size 尺寸:

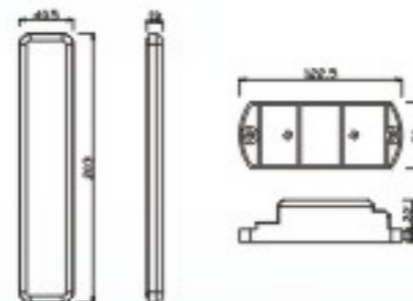

Technical data 技术参数:

Power input 工作电压	AC/DC 12-36V AC/DC 12~36V
Frequency 工作频率	433Hz 433Hz
Static current 静态电流	15mA 15mA
Action current 动作电流	80mA (DC12V Power) 80mA (无线接收器)

YS406

Wired push button
有线手押开关



Product features:

1. Small size design: Instead of normal square push button.
2. Output connection: Apply to all kinds of electronic Access control.

产品特点:

1. 长条形设计, 代替传统方形出门开关, 便于窄型门框的安装。
2. 开关接点输出, 适用于所有电子门禁系统安装。

Size 尺寸:



Technical data 技术参数:

Working voltage 工作电压	12V DC 12VDC
Working times 按钮次数	more than 600000 times 大于60万次

YS408

Infrared hand sensor switch
红外手感应开关



Product features:

1. Apply the infrared modulation touchless and clean.
2. With Induction light display.
3. The detecting distance can be adjusted.

产品特点:

1. 采用红外调制方式, 非接触设计, 洁净卫生。
2. 另有有感应灯光指示。
3. 感应距离可调节。

Size 尺寸:



Technical data 技术参数:

Power supply 供电电源	AC/DC12V-36V AC/DC12V ~ 36V
Detect distance 感应距离	1-30CM adjustable 1 ~ 30CM 可调
Working temperature 环境温度	-20°C ~45°C -20°C ~45°C

YS409

Infrared touchless sensor
红外非触感应开关



Product features:

1. Detect distance:1-30cm.
2. Apply to all kinds of electronic Access control.

产品特点:

1. 感应距离 1-30cm。
2. 按钮适用于所有电子门禁系统安装。

Size 尺寸:

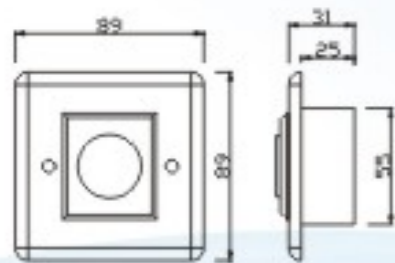

Technical data 技术参数:

Power supply 输入电压	DC 12V,DC 10-28V DC 12V,DC 10-28V
Detect distance 感应距离	1-30CM adjustable 1 ~ 30CM 可调

YS501

Access keypad
门禁一体机



Product features:

1. Door open method:1.ID Card 2.Password 3.ID Card with password.
- 2.Can connect with access switch,and control the lock working status,with High Anti interference ability and self protect function.

产品特点:

1. 开门方式: 支持感应卡、密码、感应卡加密码 三种开门方式。
2. 可接出门开关, 控制电锁开启, 具有抗干扰能力和自我保护诊断功能。

Size 尺寸:

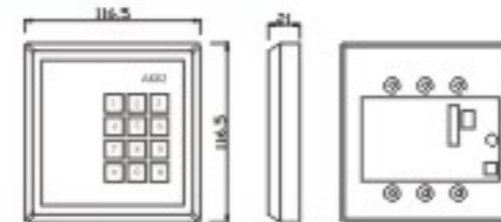

Technical data 技术参数:

Working voltage 工作电压	DC12V DC12V
Storage capacity 存储容量	800 user 800 个标准用户
Max. card detect distance 最大读卡距离	15-20cm 15-20CM

YS410

Infrared touchless sensor
红外非触感应开关



Product features:

1. Detect distance:1-30cm.
2. Apply to all kinds of electronic Access control.
3. LED light keep blue when standby mode turn to red when in detect condition.

产品特点:

1. 感应距离 1-30cm。
2. 按钮适用于所有电子门禁系统安装。
3. 待机时显示蓝色 LED 灯常亮, 触摸感应时红灯显示。

Size 尺寸:



Technical data 技术参数:

Input voltage 输入电压	AC/DC 12-36V AC/DC 12-36V
Output connection 接点输出	NO/NC/COM NO/NC/COM 接点
Detect distance 感应距离	1-30CM adjustable 1 ~ 30CM 可调

YS502

Access keypad (metal type)
金属门禁机



Product features:

1. Door open method: 1.ID Card 2.Password 3.ID Card with password.
- 2.Stainless metal cover.
- 3.With always open connection,can fit with automatic door system, connect with Wiegand card reader to prove card read function both inside and out side.

产品特点:

1. 开门方式: 支持感应卡、密码、感应卡加密码 三种开门方式。
2. 不锈钢金属外壳。
3. 带有常开接点, 配合自动门系统, 外接韦根读卡头可实现里外刷卡功能。

Size 尺寸:

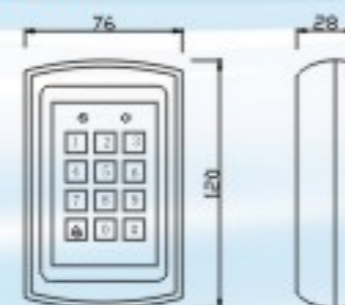

Technical data 技术参数:

Working voltage 工作电压	DC 12V DC12V
Storage capacity 存储容量	2000User 2000 个标准用户

YS503

Access keypad (metal type)
金属门禁机



Product features:

1. Door open method: 1.ID Card 2.Password 3.ID Card with password.
2. Long square Shape stainless metal cover.
3. With always open connection, can fit with automatic door system, connect with Wiegand card reader to prove card read function both inside and out side.

产品特点:

1. 开门方式: 支持感应卡、密码、感应卡加密码 三种开门方式。
2. 长条形不锈钢金属外壳。
3. 带有常开接点, 配合自动门系统, 外接韦根读卡头可实现里外刷卡功能。

Technical data 技术参数:

Working voltage	DC 12V
工作电压	DC12V
Storage capacity	1000User
存储容量	1000 个标准用户

Size 尺寸:

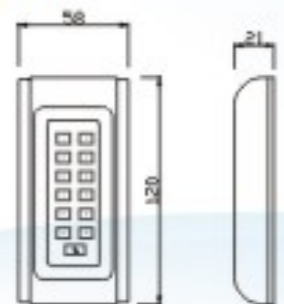

YS504

Waterproof metal access keypad
防水金属门禁机



Product features:

1. Door open method: 1.ID Card 2.Password 3.ID Card with password.
2. Waterproof stainless metal cover.
3. With always open connection, can fit with automatic door system, connect with Wiegand card reader to prove card read function both inside and out side.
4. Water protection level :IP68.

产品特点:

1. 开门方式: 支持感应卡、密码、感应卡加密码 三种开门方式。
2. 防水不锈钢金属外壳。
3. 带有常开接点, 配合自动门系统, 外接韦根读卡头可实现里外刷卡功能。
4. 防水级别 IP68。

Technical data 技术参数:

Working voltage	DC 12V
工作电压	DC12V
Storage capacity	2000User
存储容量	2000 个标准用户

Size 尺寸:



YS505

Finger print
指纹机



Product features:

1. Metal cover, anti-damage and rust-proof design.
2. Infrared remote control to add or delete users.
3. Detect fast.

产品特点:

1. 金属外壳, 防破坏、防锈设计。
2. 使用红外遥控键盘, 操作方便, 外观小巧、简洁。
3. 指纹验证方式, 使用方便, 支持指纹管理员。

Technical data 技术参数:

working voltage	DC12±10%
工作电压	DC12V ± 10%
user capacity	120
指纹存储量	120 枚 (管理员 2 枚)

Size 尺寸:

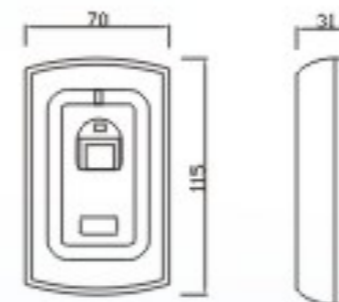

YS316

Power for access
门禁电源



Product features:

User can adjust the function from still working to always open.

产品特点:

工作模式分为停电正常工作和停电消防疏散两种 (客户自行更改设定)。

Technical data 技术参数:

Power input	AC220V
输入电压	AC220V (主控器)
Power output	DC12V ≥5A
输出电压	DC12V ≥5A(蓄电池)

Size 尺寸:

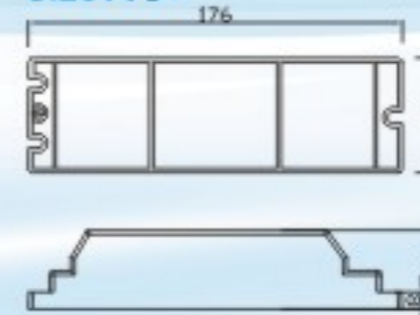

YS317 UPS 后备电源



Product features:

Popular design. When input of controller has power, it can charge the battery.

产品特点:

大众化设计, 可实现通电充电, 停电输出功能。

Size 尺寸:

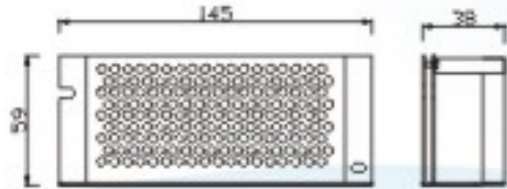

Technical data 技术参数:

Power input	AC170-264V 50Hz
输入电压	AC170-264V 50Hz (主控器)
Power output	DC24V 2.6AH(battery)
输出电压	DC24V 2.6AH (蓄电池)

ACCESSORIES



AUTOMATIC GATE

YS119

Photocell
安全光线



Size 尺寸:

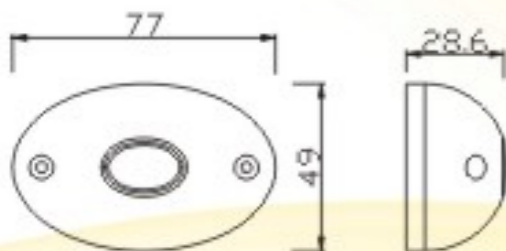

Product features:

1. Small size design, easy installation.
2. IP55, can be installed outside.

产品特点:

1. 采用微电脑控制技术, 系统集成度高, 稳定性强。
2. 发射接收距离远, 抗干扰能力强。

Technical data 技术参数:

Power input	DC12V/24V
工作电压	DC 12V/24V
Detecting range	Max 15m
探测距离	Max 15m
Working temperature	-20~+70°C
工作温度	-20~+70°C
IP class	IP55
IP 等级	IP55

YS120-L

Photocell
安全光线



Product features:

1. With flash lamp, small size design, easy installation.
2. IP54, can be installed outside.

产品特点:

1. 通电闪烁, 采用微电脑控制技术, 系统集成度高, 稳定性强。
2. 发射接收距离远, 抗干扰能力强。

Technical data 技术参数:

Power input	AC/DC 12-24V
工作电压	AC/DC 12-24V
Detecting range	≥20m
探测距离	≥20m
Working temperature	-20~+60°C
工作温度	-20~+60°C
IP class	IP54
IP 等级	IP54

YS120

Photocell
安全光线



Product features:

1. Small size design, easy installation.
2. IP54, can be installed outside.

产品特点:

1. 采用微电脑控制技术, 系统集成度高, 稳定性强。
2. 发射接收距离远, 抗干扰能力强。

Technical data 技术参数:

Power input	AC/DC 12-24V
工作电压	AC/DC 12-24V
Detecting range	≥20m
探测距离	≥20m
Working temperature	-20~+60°C
工作温度	-20~+60°C
IP class	IP54
IP 等级	IP54

YS121

Photocell
安全光线



Product features:

1. Small size design, easy installation.
2. Internal Rotation system
3. IP54, can be installed outside.

产品特点:

1. 采用微电脑控制技术, 系统集成度高, 稳定性强。
2. 内部旋转系统, 便于安装。
3. 发射接收距离远, 抗干扰能力强。

Technical data 技术参数:

Power input	AC/DC 12-24V
工作电压	AC/DC 12-24V
Detecting range	≥12m
探测距离	≥12m
Internal Rotation system, adjusted Angle	0-180°
内部旋转角度	0-180° 可调
Working temperature	-20~+60°C
工作温度	-20~+60°C
IP class	IP54
IP 等级	IP54

YS121-L Photocell 安全光线



Product features:

1. With flash LED lamp, small size design, easy installation.
2. Internal Rotation system
3. IP54, can be installed outside.

产品特点:

1. 通电LED灯闪烁, 采用微电脑控制技术, 系统集成度高, 稳定性强。
2. 内部旋转系统, 便于安装。
3. 发射接收距离远, 抗干扰能力强。

Technical data 技术参数:

Power input	AC/DC 12-24V
工作电压	AC/DC 12-24V
Detecting range	≥12m
探测距离	≥12m
Internal Rotation system, adjusted Angle	0-180°
内部旋转角度	0-180° 可调
Working temperature	-20~+60°C
工作温度	-20~+60°C
IP class	IP54
IP 等级	IP54

YS122 Photocell 安全光线



Product features:

1. Small size design, easy installation.
2. Internal Rotation system, can working with battery.
3. IP54, can be installed outside.

产品特点:

1. 采用微电脑控制技术, 系统集成度高, 稳定性强。
2. 内部旋转系统, 便于安装, 可以用电池工作。
3. 发射接收距离远, 抗干扰能力强。

Technical data 技术参数:

Power input	12-24VAC/DC or 1.5v, LR6AA size
工作电压	12-24VAC / DC或碱性5号电池
Detecting range	≥12m
探测距离	≥12m
Internal Rotation system, adjusted Angle	0-180°
内部旋转角度	0-180° 可调
Working temperature	-20~+60°C
工作温度	-20~+60°C
IP class	IP54
IP 等级	IP54

YS123 Photocell 安全光线



Product features:

1. Small size design, easy installation.
2. Inside PCBA adjustable.
3. IP54, can be installed outside.

产品特点:

1. 采用微电脑控制技术, 系统集成度高, 稳定性强。
2. 内部PCBA的角度可以调节, 便于安装。
3. 发射接收距离远, 抗干扰能力强。

Technical data 技术参数:

Power input	AC/DC 12-24V
工作电压	AC/DC 12-24V
Detecting range	≥12m
探测距离	≥12m
The angle of PCBA	±90° adjustable
PCBA旋转角度	±90° 可调
Working temperature	-20~+60°C
工作温度	-20~+60°C
IP class	IP54
IP 等级	IP54

YS415 Alarm lamp 警灯



Product features:

1. Popular design, flash normal lamp.
2. Can be used for all controllers.

产品特点:

1. 精致时尚的外观设计, 通电闪烁。
2. 适合各种控制系统。

Size 尺寸:



Technical data 技术参数:

Power input	AC 220-240V
工作电压	AC 220-240V

YS419

Alarm lamp
警灯



Product features:

1. Popular design, flash LED lamp.
2. Can be used for all controllers.

产品特点:

1. 精致时尚的外观设计, 通电LED灯闪烁。
2. 适合各种控制系统。

Size 尺寸:

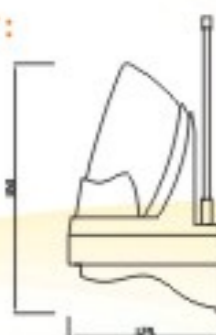

Technical data 技术参数:

Power input	DC 24V
工作电压	DC 24V

YS421

Alarm lamp
警灯



Product features:

1. Popular design, LED lamp.
2. Can be used for all controllers.

产品特点:

1. 精致时尚的外观设计, LED灯。
2. 适合各种控制系统。

Size 尺寸:



Technical data 技术参数:

Power input	DC 24V
工作电压	DC 24V

YS420

Alarm lamp
警灯



Product features:

1. Popular design, normal lamp.
2. Can be used for all controllers.

产品特点:

1. 精致时尚的外观设计。
2. 适合各种控制系统。

Size 尺寸:



Technical data 技术参数:

Power input	AC 220-240V
工作电压	AC 220-240V

YS422

Alarm lamp
警灯



Product features:

1. Popular design, flash LED lamp.
2. Can be used for all controllers.

产品特点:

1. 精致时尚的外观设计, 通电LED灯闪烁。
2. 适合各种控制系统。

Size 尺寸:



Technical data 技术参数:

Power input	AC/DC 24-265V
工作电压	AC/DC 24-265V

YS319

Alarm lamp
警灯



Product features:

1. Popular design, flash LED lamp.
2. Can be used for all controllers.

产品特点:

1. 精致时尚的外观设计,通电LED灯闪烁。
2. 适合各种控制系统。

Technical data 技术参数:

Power input	AC/DC 12-265V
工作电压	AC/DC 12-265V

YS124

Vehicle loop detector
地感



Product features:

1. Popular design.
2. Can be used for all controllers.
3. Single Channel.

产品特点:

1. 精致时尚的外观设计。
2. 适合各种控制系统。
3. 单通道。

Technical data 技术参数:

Power input	230V AC, 115V AC, 24V DC/AC, 12V DC/AC
工作电压	230V AC, 115V AC, 24V DC/AC, 12V DC/AC 可选
Reaction time	10ms
反应时间	10ms
Sensitivity	Adjustable in 4 increments
灵敏度	四级可调

YS125

Vehicle loop detector
地感



Product features:

1. Popular design.
2. Can be used for all controllers.
3. Double Channels.

产品特点:

1. 精致时尚的外观设计。
2. 适合各种控制系统。
3. 双通道。

Technical data 技术参数:

Power input	220V AC
工作电压	220V AC
Reaction time	20ms
反应时间	20ms
Sensitivity	Adjustable in 4 increments
灵敏度	四级可调

YS126

Vehicle loop detector
地感



Product features:

1. Popular design.
2. Can be used for all controllers.
3. Single Channel.

产品特点:

1. 精致时尚的外观设计。
2. 适合各种控制系统。
3. 单通道。

Technical data 技术参数:

Power input	220V AC
工作电压	220V AC
Output mode	Electric relay
输出方式	继电器输出
Reaction time	10ms
反应时间	10ms
Sensitivity	Adjustable in 3 increments
灵敏度	三级可调

YS127

Vehicle loop detector
地感



Product features:

1. Popular design.
2. Can be used for all controllers.
3. Single Channel.

产品特点:

1. 精致时尚的外观设计。
2. 适合各种控制系统。
3. 单通道。

Technical data 技术参数:

Power input	220V AC
工作电压	220V AC
Relay output	DC24V/3A
继电器输出	DC24V/3A
Reaction time	20ms
反应时间	20ms
Sensitivity	10 grades adjustable
灵敏度	十级可调

YS128

Vehicle loop detector
地感



Product features:

1. Popular design.
2. Can be used for all controllers.
3. Double Channels.

产品特点:

1. 精致时尚的外观设计。
2. 适合各种控制系统。
3. 双通道。

Technical data 技术参数:

Power input	220V AC
工作电压	220V AC
Relay output	DC24V/3A
继电器输出	DC24V/3A
Reaction time	10ms
反应时间	10ms
Sensitivity	10 grades adjustable
灵敏度	十级可调

YS416/7/8

Key switch for roller shutter
卷帘门钥匙开关



Size 尺寸:

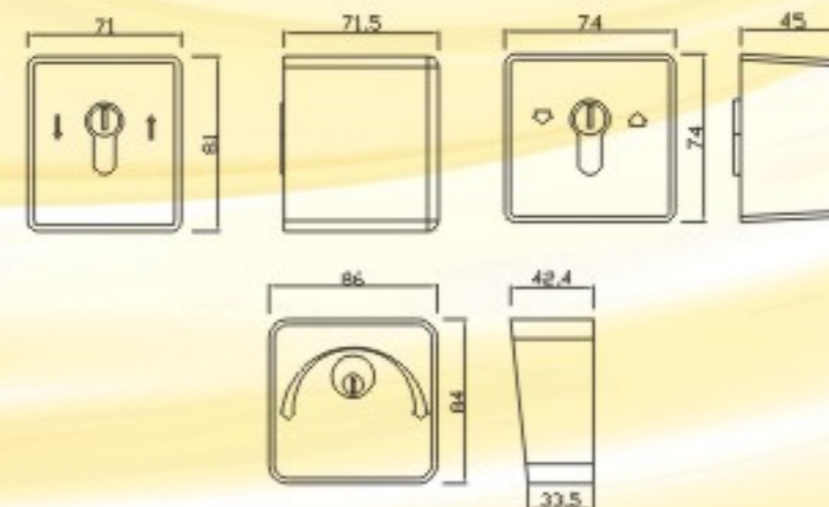

YS504

Waterproof access keypad 防水门禁机



Product features:

1. Door open method: ID card, password, ID card with password.
2. Waterproof type.
3. It can work with automatic door system and card readers.
4. IP class: IP68.

产品特点:

1. 开门方式: 支持感应卡、密码、感应卡加密码三种开门方式。
2. 防水不锈钢金属外壳。
3. 带有常开接点, 配合自动门系统, 外接韦根读卡头可实现门外刷卡功能。
4. 防水级别 IP68。

Size 尺寸:

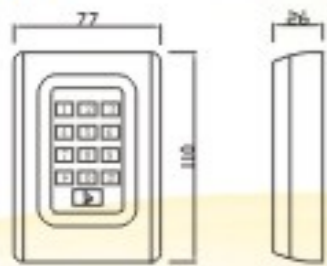

Technical data 技术参数:

Power supply	DC12V
工作电压	DC 12 V
Capacity	2000 users
存储容量	2000 个用户

ACCESS SYSTEM



YS522/3/4/6

Card reader
三灯读头



Product features:

1. Work with IC card or ID card.
2. Used for access system, packing system and so on.

产品特点:

1. IC、ID 卡。
2. 适用于门禁系统、考勤系统、楼宇、宾馆、小区、停车场等各种 RFID 射频识别领域。

Technical data 技术参数:

Working voltage	DC12V
工作电压	DC12V
Card type	ID card or IC card
读卡类型	IC/ID 卡
Working mode	Wiegand26
工作模式	Wiegand26

Size 尺寸:



YS202-2

Electric bolt lock
二线低温电插锁



Product features:

1. Two wires electric bolt lock with installing brackets are suitable for many types models automatic doors.
2. These types installing brackets will not work problem with bolt lock.

产品特点:

1. 通电磁感上锁，断电开启，低温双线电插锁适合各类自动门。
2. 独特的安装支架与锁舌不会产生误操作。

Technical data 技术参数:

Power supply	DC12V
电源输入	DC12V
Working current	300mA
工作电流	300mA
Start up current	800mA
启动电流	800mA

Size 尺寸:

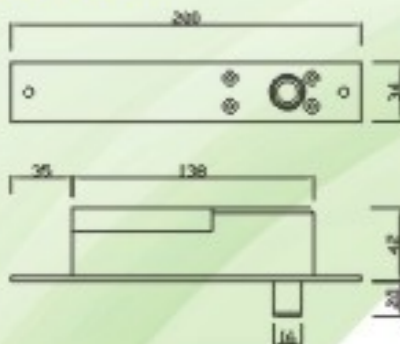

YS205-1

Time delay electric lock
五线低温延时电插锁



Product features:

1. Locked with power and released when power failure.
2. Delay opening time can be adjusted, and had function of status feeding back.
3. Applied for wooden door, metal door, anti-fire door and automatic door.

产品特点:

1. 通电磁感上锁，断电开启。
2. 具有翘板开关调节延时时间，有门状态和锁状态信号输出。
3. 适用于木门，金属门，防火门，自动门使用。

Technical data 技术参数:

Power supply	DC12V
电源输入	DC12V
Working current	90mA
工作电流	90mA
Start up current	800mA
启动电流	800mA
Delay opening time	0s, 3s, 6s, 9s
上锁延时	(0、3、6、9秒)可调

Size 尺寸:

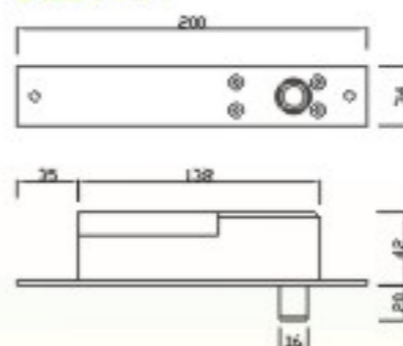

YS660

Magnetic lock(60kg)
60KG 明装磁力锁



Product features:

1. Low noise, long life.
2. Small size suit for small door or special usage.

产品特点:

1. 利用电流产生强大的磁场从而使锁吸合。无噪音，耐磨损。
2. 可用文件柜，小门型使用。

Technical data 技术参数:

Power input	DC12V/24V
输入电压	DC12V/24V
Working current	12V/300mA, 24V/150mA
工作电流	12V/300mA, 24V/150mA
Capacity	60KG
承受拉力	60KG

Size 尺寸:

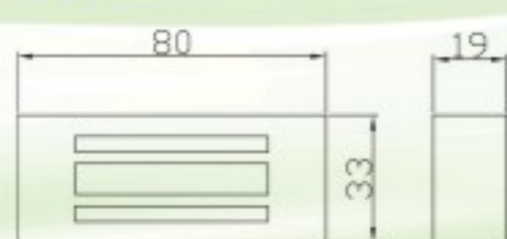

YS6-180

Magnetic lock(180kg)
180KG 明装磁力锁



Product features:

1. Low noise, long life.
2. Most popular for access system.

产品特点:

1. 利用电流产生强大的磁场从而使锁吸合。无噪音, 耐磨损。
2. 可以楼宇和门禁系统配套使用, 采用电控磁力关门自动上锁。

Size 尺寸:

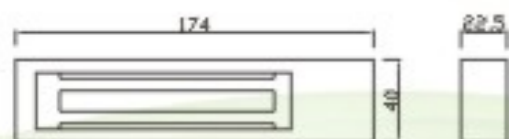

Technical data 技术参数:

Power input	DC12V/24V
输入电压	DC12V/24V
Working current	12V/300mA, 24V/150mA
工作电流	12V/300mA, 24V/150mA
Capacity	180KG
承受拉力	180KG

YS6-500

Magnetic lock(500kg)
500KG 明装磁力锁



Product features:

1. Low noise, long life.
2. Most popular for access system.

产品特点:

1. 利用电流产生强大的磁场从而使锁吸合。无噪音, 耐磨损。
2. 可以楼宇和门禁系统配套使用, 采用电控磁力关门自动上锁。

Size 尺寸:



Technical data 技术参数:

Power input	DC12V/24V
输入电压	DC12V/24V
Working current	12V/500mA, 24V/250mA
工作电流	12V/500mA, 24V/250mA
Capacity	500KG
承受拉力	500KG

YS6-280

Magnetic lock(280kg)
280KG 明装磁力锁



Product features:

1. Low noise, long life.
2. Most popular for access system.

产品特点:

1. 利用电流产生强大的磁场从而使锁吸合。无噪音, 耐磨损。
2. 可以楼宇和门禁系统配套使用, 采用电控磁力关门自动上锁。

Size 尺寸:

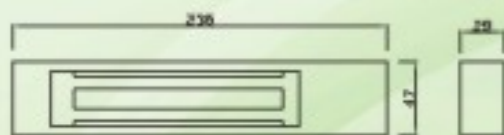

Technical data 技术参数:

Power input	DC12V/24V
输入电压	DC12V/24V
Working current	12V/450mA, 24V/225mA
工作电流	12V/450mA, 24V/225mA
Capacity	280KG
承受拉力	280KG

YS6-180M

Magnetic lock(180kg)
180KG 双开磁力锁



Product features:

1. Low noise, long life.
2. Most popular for access system.

产品特点:

1. 利用电流产生强大的磁场从而使锁吸合。无噪音, 耐磨损。
2. 可以楼宇和门禁系统配套使用, 采用电控磁力关门自动上锁。

Size 尺寸:

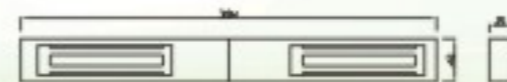

Technical data 技术参数:

Power input	DC12V/24V
输入电压	DC12V/24V
Working current	12V/450mA, 24V/225mA
工作电流	12V/450mA, 24V/225mA
Capacity	180KG
承受拉力	180KG

YS6-280M

Magnetic lock(280kg)
280KG 双门磁力锁



Product features:

1. Low noise, long life.
2. Most popular for access system.

产品特点:

1. 利用电流产生强大的磁场从而使锁吸合。无噪音，耐磨损。
2. 可以楼宇和门禁系统配套使用，采用电控磁力关门自动上锁。

Size 尺寸:



Technical data 技术参数:

Power input	DC12V/24V
输入电压	DC12V/24V
Working current	12V/450mA, 24V/225mA
工作电流	12V/450mA, 24V/225mA
Capacity	280KG
承受拉力	280KG

YS6-280A

Magnetic lock(280kg)
280KG 暗装磁力锁



Product features:

1. Low noise, long life.
2. Most popular for access system.

产品特点:

1. 利用电流产生强大的磁场从而使锁吸合。无噪音，耐磨损。
2. 可以楼宇和门禁系统配套使用，采用电控磁力关门自动上锁。

Size 尺寸:

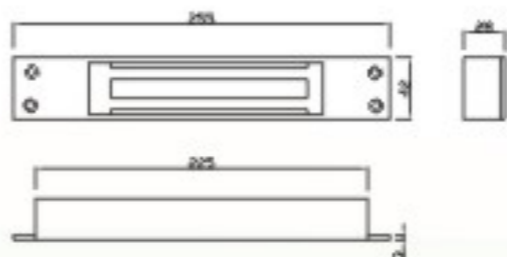

Technical data 技术参数:

Power input	DC12V/24V
输入电压	DC12V/24V
Working current	12V/450mA, 24V/225mA
工作电流	12V/450mA, 24V/225mA
Capacity	280KG
承受拉力	280KG

YS6-180A

Magnetic lock(180kg)
180KG 暗装磁力锁



Product features:

1. Low noise, long life.
2. Most popular for access system.

产品特点:

1. 利用电流产生强大的磁场从而使锁吸合。无噪音，耐磨损。
2. 可以楼宇和门禁系统配套使用，采用电控磁力关门自动上锁。

Size 尺寸:

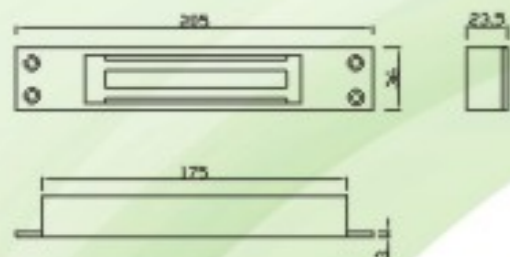

Technical data 技术参数:

Power input	DC12V/24V
输入电压	DC12V/24V
Working current	12V/300mA, 24V/150mA
工作电流	12V/300mA, 24V/150mA
Capacity	180KG
承受拉力	180KG

YS6-350A

Magnetic lock(350kg)
350KG 暗装磁力锁



Product features:

1. Low noise, long life.
2. Most popular for access system.

产品特点:

1. 利用电流产生强大的磁场从而使锁吸合。无噪音，耐磨损。
2. 可以楼宇和门禁系统配套使用，采用电控磁力关门自动上锁。

Size 尺寸:



Technical data 技术参数:

Power input	DC12V/24V
输入电压	DC12V/24V
Working current	12V/500mA, 24V/250mA
工作电流	12V/500mA, 24V/250mA
Capacity	350KG
承受拉力	350KG